

2020 HYDROPOOL Self-Cleaning Swim Spa Quick Start Guide



HYDROPOOL
the self-cleaning swim spa

To View The Quick Start Guide Video Download the HydroPool App FREE from Google Play and Apple App Store to bring to life this brochure with 



Lets Get Started...

NOTE: BEFORE FILLING OR USING THIS SWIM SPA ENSURE YOU HAVE FOLLOWED THE HYDROPOOL INSTALLATION GUIDE.



(Fig.1)



(Fig.2)



(Fig.3)



(Fig.4)

1. Equipment Inspection:

To access the equipment area remove the side strips using the appropriate screw driver. The cabinet panel is magnetically fastened and can be removed with one swift pull from the bottom of the panel. Once the panel is removed inspect the unions and ensure they are tight.

DO NOT USE A WRENCH, HAND TIGHTEN ONLY.

Inspect the gate valves are in the open position and stem locks in place (Fig.1). Never run the swim spa with the gate valve closed or without water circulation.

Leave door off until after start up.

2. Install Your Safety Hard Cover:

Carefully remove the safety cover from the packaging and position on swim spa. Packaged with the cover are the safety clips. (Usually affixed to the handle). Once you are satisfied with the direction the cover is opening you will need to attach the tie down clips (Fig.2). Refer to the manual with the cover for installation instructions.

3. Fill Instructions:

- Place a standard garden hose from a clean sanitized water source into the skimmer & fill the Swim Spa (Fig. 3).
 - Always fill the swim spa through the skimmer.
 - Never fill the swim spa with hot water.
 - Never fill the swim spa with soft water, please consult your local retailer.
- Fill the swim spa up to 1" below the top skimmer opening. Once the water is at the proper height turn off the water and remove the garden hose (Fig.3).

4. Powering up the Swim Spa

- Turn on the breaker in the main panel of your house.
- Turn on the breaker located near the swim spa (Fig.4). Your swim spa will automatically go through the start-up procedure and the water will start to circulate. All pumps and blowers will turn on for 1 minute.



(Fig.5b)



(Fig.6)



(Fig.7)

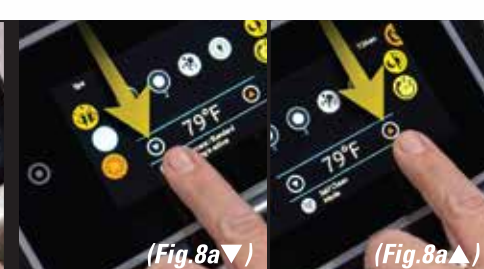

(Fig.8a▼)

(Fig.8a▲)

5. Trouble Shooting

- If your tub is circulating check the Pump / Spa Pack union's in the equipment area for any leaks. If there is no water present, re-install your equipment door.
- After your Swim Spa is circulating, bleed any air from the filter area to ensure proper filtration using the air bleeder valve located on the lid of the filter (Fig.5).

6. Electronic Control Operation

- Touch** the screen of the topside control and drag the icon on the right over the icon on your left to open the menu (Fig.6).
- Please Note:** After 15 minutes of no interaction with the keypad the screen will go black and the keypad will turn off.

7. Pump Operation

- Press** the pumps icon to activate the pumps. (Fig.7). After pressing the button please make sure water is circulating through the jets. If there is no circulation, you may have an air lock. Please refer to owners manual to clear the air lock.

8a. Adjusting Water Temperature

- The Buttons (On-screen Icons) to increase or decrease the temperature are located on the main screen. **Press** the Blue (Down Pointing) Arrow (Fig.8a▼) to lower the temperature and **Press** the Red (Upward Pointing) Arrow (Fig.8a▲) to increase it. Your set point will appear in blue.



(Fig.8b)



(Fig.9)



(Fig.10)



(Fig.11a)

(Fig.11b)

8b. Setting Water Temperature

- After 3 seconds without any change to the set point the current water temperature will reappear in white (Fig.8b).

9) Illumination (Lights)

- Press** the Light icon to turn the lights on or off. The first push will turn the lights on and start the color sequence rotation (Fig.9).

10) Choosing A Color

- Press** the light button and scroll through the color selection by repeatedly pressing the light button (Fig.10) until you have reached your preferred color. It will automatically stay on that color from this point forward.

11) Setting Date & Time

- From the Main Screen, **Press** the Settings Button (On-screen Icon) to open the setting menu (Fig.11a) it is the button with all the little gears. Then select Date and Time (Fig.11b).



(Fig.12a)

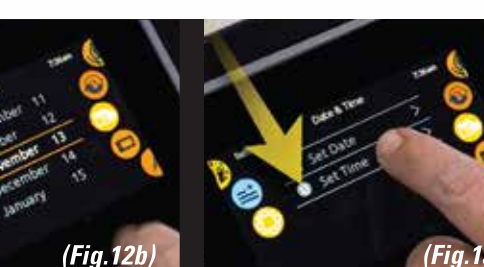

(Fig.12b)



(Fig.13a)



(Fig.14)

12. Choosing Date & Time

- Press** the Calendar icon to go to the Set Date menu (Fig.12a). Scroll up and down on the touch screen to align the proper Year, Month and Day in between the two orange lines (Fig.12b).

13. Date & Time Selection

- Press** the Clock icon to go to the Set Time menu (Fig.12a). Scroll up and down on the touch screen to align the proper Hour, Minutes and AM vs. PM in between the two orange lines (Fig.12b).

14. For Other Menu Options

- Then **Press** the Settings icon to get back to the setting menu or the Wave icon to get back to your normal operation screen (Fig.14). There are many other programmable features available in the setting screen. Refer to the owner's manual to make changes from the factory setting.

Your Swim Spas Water Chemistry...

15. Adjust the Water Chemistry

By now you should have brought a water sample into your local retailer and they have given you instructions on how to adjust your water chemistry. See your owner's manual or follow your authorized HydroPool dealer's instructions, to test and adjust the water chemistry.

Caution – Untreated water can be hazardous to your health and can cause damage to your swim spa equipment.

Before filling or using this swim spa ensure you have followed the HydroPool installation guide.

Congratulations – within a few hours you will be enjoying the relaxing therapeutic benefits of your new HydroPool Self-Clean Swim Spa. Enjoy!

1) Poor water maintenance will cause: rust, cushions and cover to deteriorate, leaks, faulty heater elements, pump seal failures and jets to stop working.

2) Head cushions should be placed out of the tub when not used.

16. Importance of Keeping Your Swim Spa Water Balanced and Sanitized.

Please remember: the temperature of the spa water is most often set at 99°F / 37°C which means that there's huge opportunity for bacteria growth in a swim spa. It can also cause cloudy water, generate excess foaming and damage the spa surface as well as the equipment (pump seal, covers, cushions, create rust).

MAINTAIN CLEAN WATER – HOW TO PROCEED:

- Filtration:** As a start have your Filtration run 24 hours/day (all day, in case of filtration pump equipment) and clean your Filter weekly.
- pH:** If your pH is unbalanced you will have a low disinfection efficiency and also risk to damaging the equipment.

The ideal pH range for spas is 7.2 to 7.6.

To keep between these parameters, you will need to use a test kit.

3) Sanitizers

Sanitizers are used to effectively disinfect and keep water smelling fresh. The two most popular ones are chlorine and bromine. You can test these by using a test kit, follow the procedures written on the bottles to place the proper dosage in the pool. Proper reading for Chlorine is 1.5 - 3.0 PPM and 3.0 - 5.0 PPM for Bromine. We suggest a shock sanitization on the first fill or water change. This operation can be repeated up to once a month or more regularly with a Shock chemical.

GENERAL INSTRUCTIONS: please check the volume of your swim spa or swim spa before you dose the chemicals products. All the instructions regarding the amount of chemicals to place in your pool are specified on each bottle (PH, Sanitizer, Test kits etc.). Especially at the beginning of your chemical water care learning, we suggest you place the chemicals in separate bucket in which you have extracted water from your swim spa in order to prevent any chemical surcharge.

17. Next level... SANITIZERS

Chlorine

Chlorine is a very effective sanitizer; it has been used in pools and spas for many years but is not popular because of its harshness, strong odor and is less stable in hot water. If this is the sanitizer that you have chosen you will find it available in granular and tablet forms. The Chlorine levels to maintain a bacteria free tub is 1-3 ppm. A test kit or test strips are required to help achieve this balance. This choice is the most popular and convenient because it is very aggressive and works very quickly.

Bromine

Bromine is very effective and does not have a "strong odor" that chlorine typically has. It is available in granular and tablet form. To maintain a bacteria free tub the correct levels for bromine is 3.0 - 5.0 PPM. Bromine is a slower reacting sanitizer which means closer monitoring of the levels is required, this is done by using a test kit or test strips.

Scale

We suggest you use a Scale Inhibitor regularly to ensure no damage or scaling of equipment and tub surface.

Total Alkalinity (TA)

If the water does not have enough Alkalinity, the water will draw from other minerals. This will result in equipment corrosion. Use TA+ to increase Alkalinity level (pH down will reduce it) – Check Alkalinity level once a week. Total alkalinity readings should stay inside the acceptable range. Be careful, pH lowering chemicals will lower the total alkalinity as well. Again, to help achieve these readings you will need a test kit or test strips.

Please Note: Consult your local retailer for best practices on water chemistry. Also when adding chemicals your swim spa cover should be off and the swim spa jets running.

NEVER LEAN OR STAND ON YOUR HARDCOVER.

NOTE: ALWAYS ENSURE THE SAFETY HARDCOVER IS IN PLACE AND LOCKED WHENEVER THE SWIM SPA IS NOT BEING USED. FAILURE TO DO SO MAY CAUSE DAMAGE OR CRACKING OF THE ACRYLIC SURFACE NOT COVERED UNDER THE WARRANTY.

For instructions on draining your swim spa please refer to your Self-Cleaning Swim Spa Owner's Manual.

IMPORTANT SAVE THESE INSTRUCTIONS

Your physiological response to hot water is subjective and depends on your age, health, and medical history. If you don't know your response to hot water, or if you get a headache, or become dizzy or nauseous when using your swim spa, get out and cool off immediately.



HYDROPOOL
the self-cleaning swim spa



WARNING

1. CHILDREN SHOULD NOT USE SPAS OR SWIM SPAS WITHOUT ADULT SUPERVISION.
2. DO NOT USE SPAS OR SWIM SPAS UNLESS ALL SUCTION GUARDS ARE INSTALLED TO PREVENT BODY AND HAIR ENTRAPMENT.
3. PEOPLE USING MEDICATIONS AND/OR HAVING ANY ADVERSE MEDICAL HISTORY SHOULD CONSULT A PHYSICIAN BEFORE USING A SPA OR SWIM SPA.
4. PEOPLE WITH INFECTIOUS DISEASES SHOULD NOT USE A SPA OR SWIM SPA.
5. TO AVOID INJURY, EXERCISE CARE WHEN ENTERING OR EXITING THE SPA OR SWIM SPA.
6. DO NOT USE DRUGS OR ALCOHOL BEFORE OR DURING THE USE OF A SPA OR SWIM SPA, TO AVOID UNCONSCIOUSNESS AND POSSIBLE DROWNING.
7. PREGNANT OR POSSIBLE PREGNANT WOMEN SHOULD CONSULT A PHYSICIAN BEFORE USING A SPA OR SWIM SPA.
8. WATER TEMPERATURE IN EXCESS OF 38°C (100°F) MAY BE INJURIOUS TO YOUR HEALTH.
9. BEFORE ENTERING THE SPA OR SWIM SPA, MEASURE THE WATER TEMPERATURE WITH AN ACCURATE THERMOMETER.
10. DO NOT USE A SPA OR A SWIM SPA IMMEDIATELY FOLLOWING STRENUOUS EXERCISE.
11. PROLONGED IMMERSION IN A SPA OR SWIM SPA MAY BE INJURIOUS TO YOUR HEALTH.
12. DO NOT PERMIT OR USE ELECTRIC APPLIANCES (SUCH AS LIGHT, TELEPHONE, RADIO OR TELEVISION) WITHIN 1.5M (5FT) OF THIS SPA OR SWIM SPA.
13. CHILDREN SHOULD NOT ENTER A SWIM SPA WHERE THE WATER TEMPERATURE EXCEEDS BODY TEMPERATURE (37° C / 98.6°F).
14. DO NOT ALLOW CHILDREN TO SUBMERGE THEIR HEAD UNDER WATER.

15. NEVER OPERATE THE SWIM SPA PUMP AT HIGH SPEED WITHOUT HAVING ALL SUCTION AND RETURN LINES OPEN.
16. ALWAYS KEEP THE HARDCOVER INSTALLED AND LOCKED WHEN THE SWIM SPA IS NOT IN USE.
17. TEST THE GFCI (GROUND FAULT CIRCUIT INTERRUPTER) MONTHLY.
18. POST EMERGENCY PHONE NUMBERS FOR POLICE, FIRE DEPARTMENT, AND AMBULANCE AT THE NEAREST PHONE.
19. TO REDUCE THE RISK OF INJURY
 - THE WATER IN A SPA SHOULD NEVER EXCEED 40°C (104°F). WATER TEMPERATURES BETWEEN 38°C (100°F) AND 40°C (104°F) ARE CONSIDERED SAFE FOR A HEALTHY ADULT. LOWER WATER TEMPERATURES ARE RECOMMENDED FOR YOUNG CHILDREN AND WHEN SPA USE EXCEEDS 10 MINUTES.
 - SINCE EXCESSIVE WATER TEMPERATURES HAVE A HIGH POTENTIAL FOR CAUSING FETAL DAMAGE DURING THE EARLY MONTHS OF PREGNANCY, PREGNANT OR POSSIBLY PREGNANT WOMEN SHOULD LIMIT SPA WATER TEMPERATURES TO 38°C (100°F).
 - BEFORE ENTERING A SPA, THE USER SHALL MEASURE THE WATER TEMPERATURE SINCE THE TOLERANCE FOR WATER TEMPERATURE REGULATING DEVICES VARIES.
 - THE USE OF ALCOHOL, DRUGS, OR MEDICATION BEFORE OR DURING SPA USE MAY LEAD TO UNCONSCIOUSNESS, WITH THE POSSIBILITY OF DROWNING.
 - OBESE PERSONS AND PERSONS WITH A HISTORY OF HEART DISEASE, LOW OR HIGH BLOOD PRESSURE, CIRCULATORY SYSTEM PROBLEMS OR DIABETES SHOULD CONSULT A PHYSICIAN BEFORE USING A SPA.
 - PERSONS USING MEDICATION SHOULD CONSULT A PHYSICIAN BEFORE USING A SPA SINCE SOME MEDICATION MAY INDUCE DROWSINESS WHILE OTHER MEDICATION MAY EFFECT HEART RATE, BLOOD PRESSURE AND CIRCULATION.

CAUTION

1. MAINTAIN WATER CHEMISTRY IN ACCORDANCE WITH THE MANUFACTURER'S INSTRUCTIONS.

DANGER

1. RISK OF ACCIDENTAL DROWNING. EXTREME CAUTION MUST BE EXERCISED TO PREVENT UNAUTHORIZED ACCESS BY CHILDREN. TO AVOID ACCIDENTS, ENSURE THAT CHILDREN CAN'T USE THE SPA UNLESS THEY ARE SUPERVISED AT ALL TIMES.
2. RISK OF INJURY. THE SUCTION FITTINGS IN THIS SPA ARE SIZED TO MATCH THE SPECIFIC WATER FLOW CREATED BY THE PUMP. SHOULD THE NEED ARISE TO REPLACE THE SUCTION FITTINGS OR THE PUMP, BE SURE THAT THE FLOW RATES ARE COMPATIBLE. NEVER OPERATE THE SPA IF THE SUCTION FITTINGS ARE BROKEN OR MISSING. NEVER REPLACE A SUCTION FITTING WITH ONE RATED LESS THAN THE FLOW RATE MARKED ON THE ORIGINAL SUCTION FITTING.
3. RISK OF ELECTRIC SHOCK. INSTALL AT LEAST 1.5M (5FT) FROM ALL METAL SURFACES. AS AN ALTERNATIVE, A SPA MAY BE INSTALLED WITHIN 1.5M (5FT) OF METAL SURFACES IF EACH METAL SURFACE IS PERMANENTLY CONNECTED BY A MINIMUM 8 AWG (8.4 mm²) SOLID COPPER CONDUCTOR TO THE WIRE CONNECTOR ON THE TERMINAL BOX THAT IS PROVIDED FOR THIS PURPOSE.
4. RISK OF ELECTRIC SHOCK. DO NOT PERMIT ANY APPLIANCE, SUCH AS A LIGHT, TELEPHONE, RADIO, OR TELEVISION, WITHIN 1.5M (5FT) OF THE SPA.

HYPERTHERMIA

Since your hot tub can be set to reach temperatures of 40°C (104° F), users should be aware that extended submersion in water that exceeds normal body temperature can lead to hyperthermia. The causes, symptoms and effects of hyperthermia may be de-scribed as follows: Hyperthermia occurs when the internal temperature of the body reaches several degrees above the normal body temperature of 37°C (98.6°F). The symptoms of hyperthermia include drowsiness, lethargy, and an increase in the internal temperature of the body.

The effects of hyperthermia include:

- Unawareness of impending hazard
- Physical inability to exit the hot tub
- Failure to perceive heat
- Fetal damage in pregnant woman
- Failure to recognize the need to exit the hot tub
- Unconsciousness resulting in the danger of drowning

If you sense any of the symptoms of hyperthermia, safely exit the swim spa immediately.

IMPORTANT SAVE THESE INSTRUCTIONS

Your physiological response to hot water is subjective and depends on your age, health, and medical history. If you don't know your tolerance to hot water, or if you get a headache, or become dizzy or nauseous when using your hot tub, get out and cool off immediately.

WARNING

THE USE OF ALCOHOL, DRUGS OR MEDICATION CAN SIGNIFICANTLY INCREASE THE RISK OF FATAL HYPERTHERMIA.

IMPORTANT ELECTRICAL SAFETY INSTRUCTIONS

SAFETY COMES FIRST. WHEN INSTALLING & USING THIS ELECTRICAL EQUIPMENT, BASIC SAFETY PRECAUTIONS MUST ALWAYS BE FOLLOWED!

1. READ AND FOLLOW ALL INSTRUCTIONS
2. Electrical installation must be completed by a qualified electrician in accordance with all National, Regional and Local Codes and Regulations in effect at the time of installation.
3. Connect only to a dedicated circuit protected by a class 'A' two-pole ground fault circuit interrupter (GFCI).
4. Use copper conductors only!
5. The hot tub equipment and all electrical plugs, outlets and lights within 1.5m (5ft) of the unit must be G.F.C.I protected. Consult your electrician or local electrical authority for further details.
6. A green colored terminal or a terminal marked "G", "GR", "Ground", or "Grounding" is located inside the supply terminal box or compartment. To reduce the risk of electric shock, this terminal must be connected to the grounding means provided in the electric supply service panel with a continuous copper wire equivalent in size to the circuit conductors supplying the equipment.
7. At least two lugs marked "BONDING LUGS" are provided on the external surface or on the inside of the supply terminal box or compartment. To reduce the risk of electric shock, connect the local common bonding grid in the area of the hot tub to these terminals with an insulated or bare copper conductor not smaller than No.6 AWG (Canada/Europe) / No.8 AWG (USA).
8. All field installed metal components such as rails, ladders, drains or other similar hardware within 3 m (10 ft) of the hot tub shall be bonded to the equipment grounding bus with copper conductors not smaller than No.6 AWG.

IMPORTANT NOTE: (FIGURE 1)

The following dimensions can be used to determine the proper location of submerged conduits in concrete slab installations. The dimensions are made from the outside of the spa / hot tub frame with the access for panels removed. The topside control panel is shown at the bottom of the diagram as a reference.

IMPORTANT NOTE:

- This guide is for standard installations where the wire run is 15 m (50 ft.) or less. For longer wire runs, consult a qualified electrician.

G.F.C.I./R.C.D. APPLICATION GUIDE FOR HYDROPOOL SWIM SPA SERIES

NORTH AMERICA	
Aquaplay/Aquasport	50A
Aquasport 19DTFX Gold	40A spa / 50A swim
Aquatrainier	60A
Aquatrainier 19DTFX Gold	40A spa / 60A swim
EUROPE (single phase)	
Aquaplay/Aquasport	40A
Aquasport 19DTFX Gold	20A spa / 40A swim
Aquatrainier	40A
Aquatrainier 19DTFX Gold	20A spa / 40A swim

WIRE SIZE: NORTH AMERICA

- The minimum wire size for systems that require a 40A GFCI is # 8/3 c/w ground (also referred to as # 8 gauge / 4 conductor).
- The minimum wire size for systems that require a 50A GFCI is # 8/3 c/w ground (also referred to as # 8 gauge / 4 conductor).
- The minimum wire size for systems that require a 60A GFCI is # 6/3 c/w ground (also referred to as # 6 gauge / 4 conductor).

EUROPE

Standards for amperage breakers may vary from country to country in the CE controlled area. Please consult your local installer for advice on breaker level and wire specifications. Some examples are below:

Breaker of 13A – wire must be 1.5 mm²

Breaker of 16A – wire must be 2.5 mm²

Breaker of 20A – wire must be 4.0 mm²

Breaker of 32A – wire must be 6.0 mm²

NOTE: Please consult your applicable electrical codes related to the size of conductors as they may vary from what is stated above. Take into consideration the length of cable as well and increase as required.

NORTH AMERICAN – GFCI INSTALLATION

NOTICE

Installation of the GFCI - Circuit Breaker, including ampere sizing and selection of conductor size and type, must be performed by a qualified electrician in accordance with the National Electrical Code, or the Canadian Electrical Code, and all Federal, State/Provincial and local codes and regulations in effect at the time of installation. Hydropool highly recommends the use of a new Siemens GFCI breaker for all of its products. Other GFCI's and older Siemens GFCI's may have tripping issues.

240 VOLT 60Hz AQUASPORT SINGLE GFCI WIRING (MASTER ONLY)

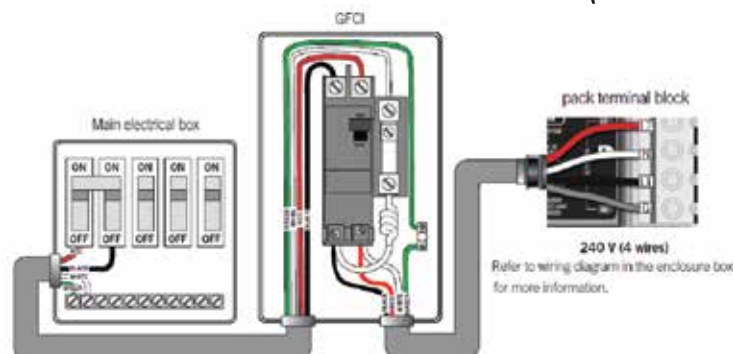

240 VOLT 60 Hz SWIMSPA SINGLE GFCI WIRING MASTER / SLAVE HEATER

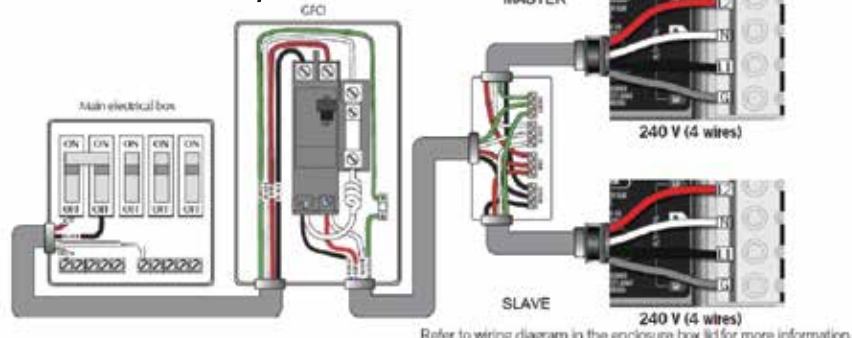

240 VOLT 60 Hz SWIMSPA DUAL GFCI WIRING MASTER / SLAVE HEATER

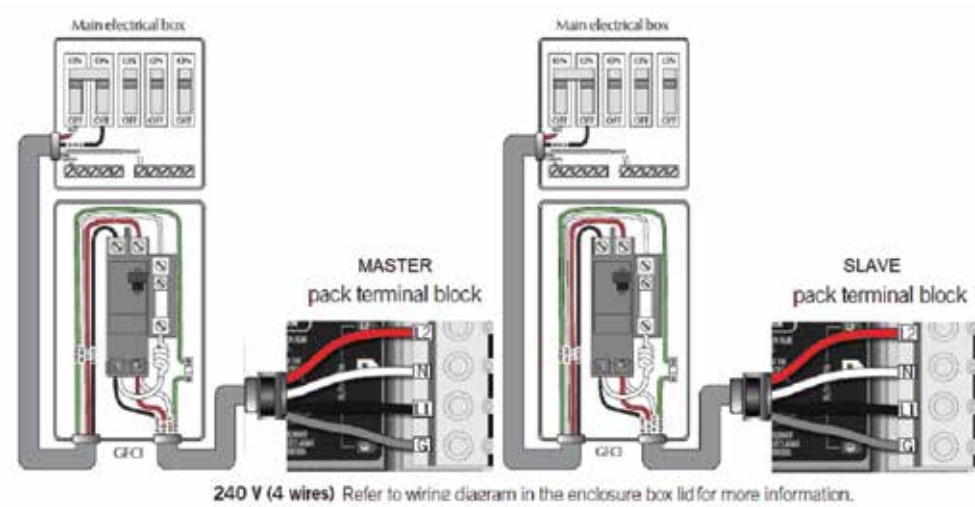

EUROPE – R.C.D. INSTALLATION - TYPICAL

NOTICE

Important Note: Installation of the R.C.D. - Circuit Breaker, including ampere sizing and selection of conductor size and type, must be performed by a qualified electrician in accordance with National, Regional and Local Codes and Regulations in effect at the time of installation.

230 VOLT 50 Hz SINGLE PHASE RCD WIRING

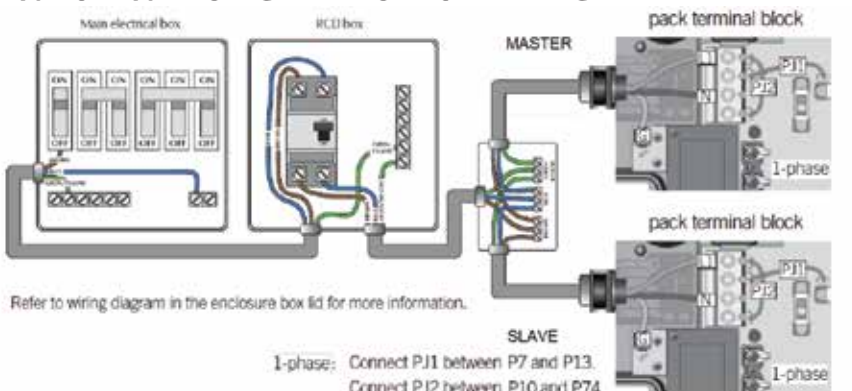

230 VOLT 50 Hz THREE PHASE RCD WIRING

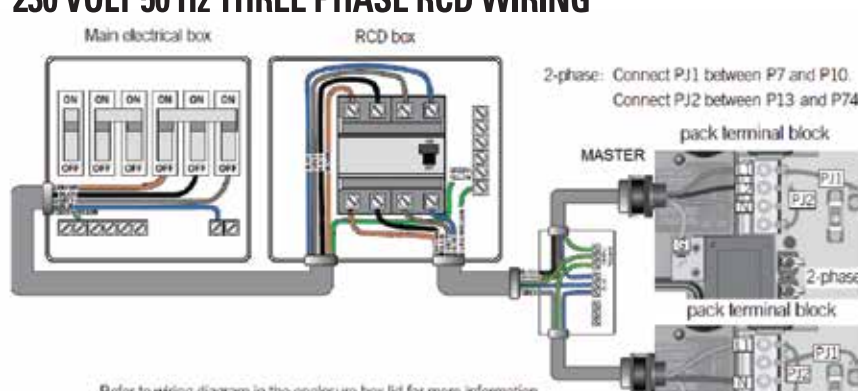

230 VOLT 50 Hz DUAL PHASE RCD WIRING

